



LIGA VOZÍČKÁŘŮ

Protože každý má svůj potenciál

MĚSTO A JEHO BARIÉRY

Ing. Arch. Adam Erben



PLÁNOVÁNÍ MĚSTA
VEŘEJNÉ PROSTORY
MOBILITA
s přihlédnutím na OSP









PLÁNOVÁNÍ MĚSTA
VEŘEJNÉ PROSTORY
MOBILITA



PĚŠKY, NA VOZÍKU, NA KOLE

HROMADNÁ DOPRAVA

AUTOMOBILOVÁ DOPRAVA



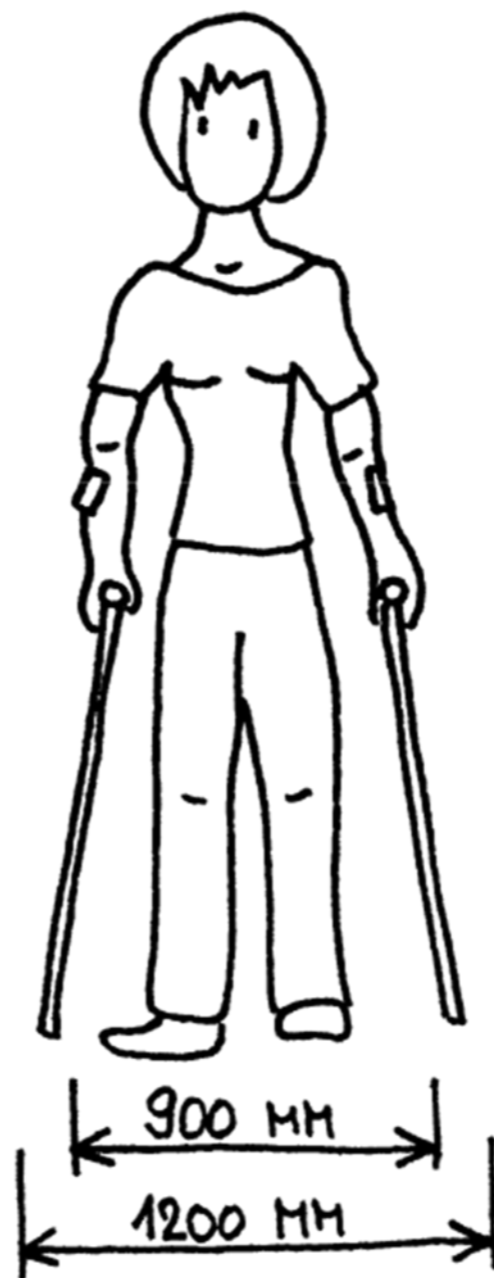

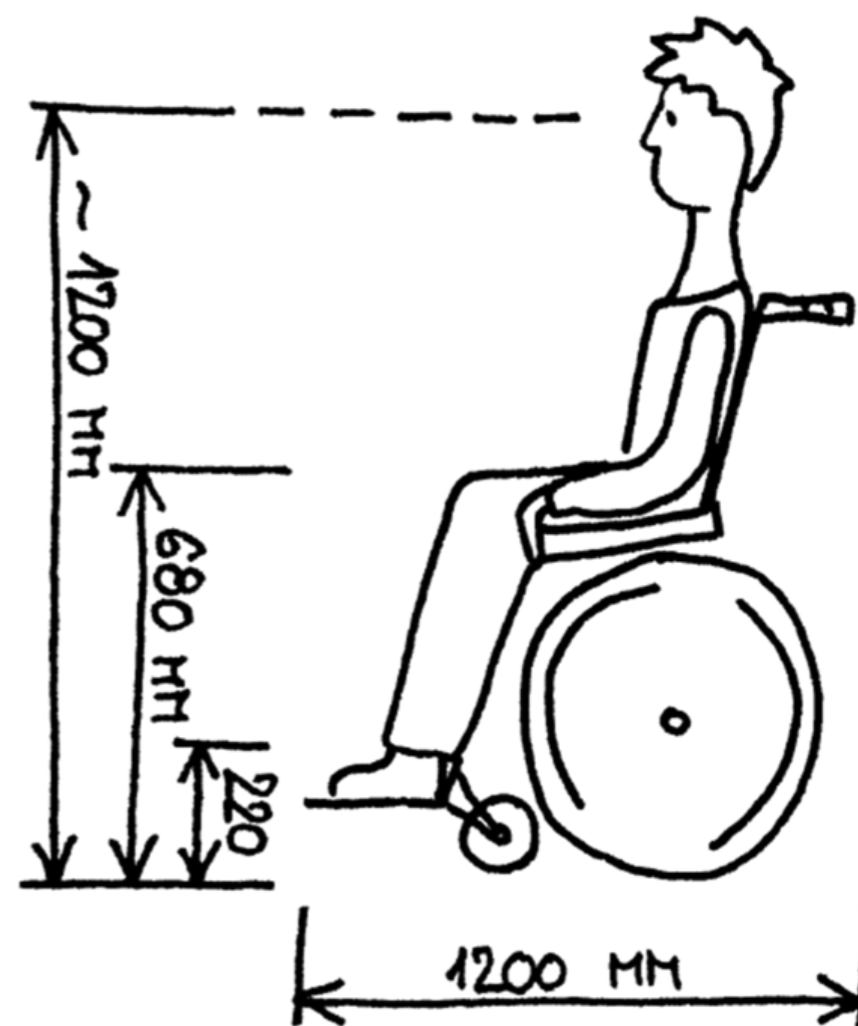
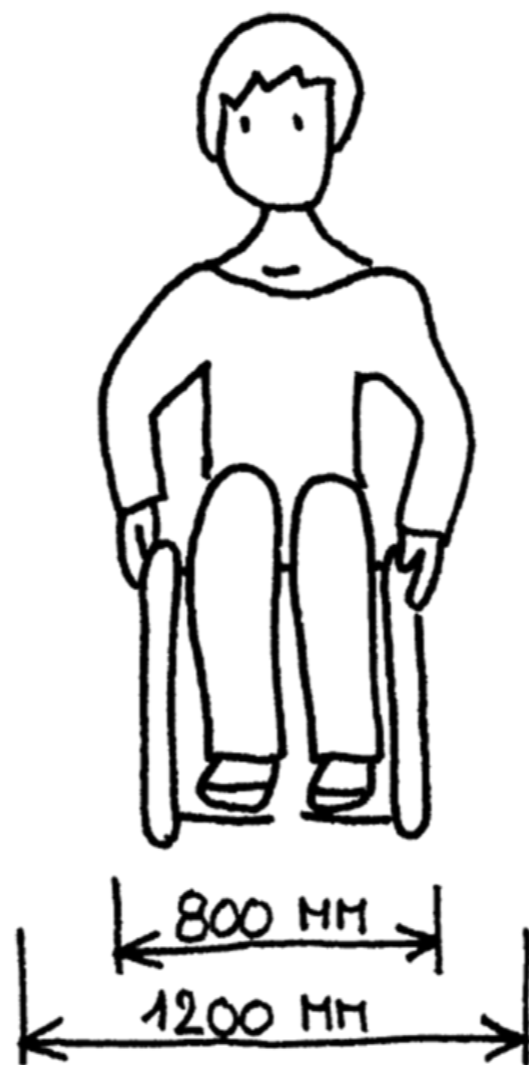
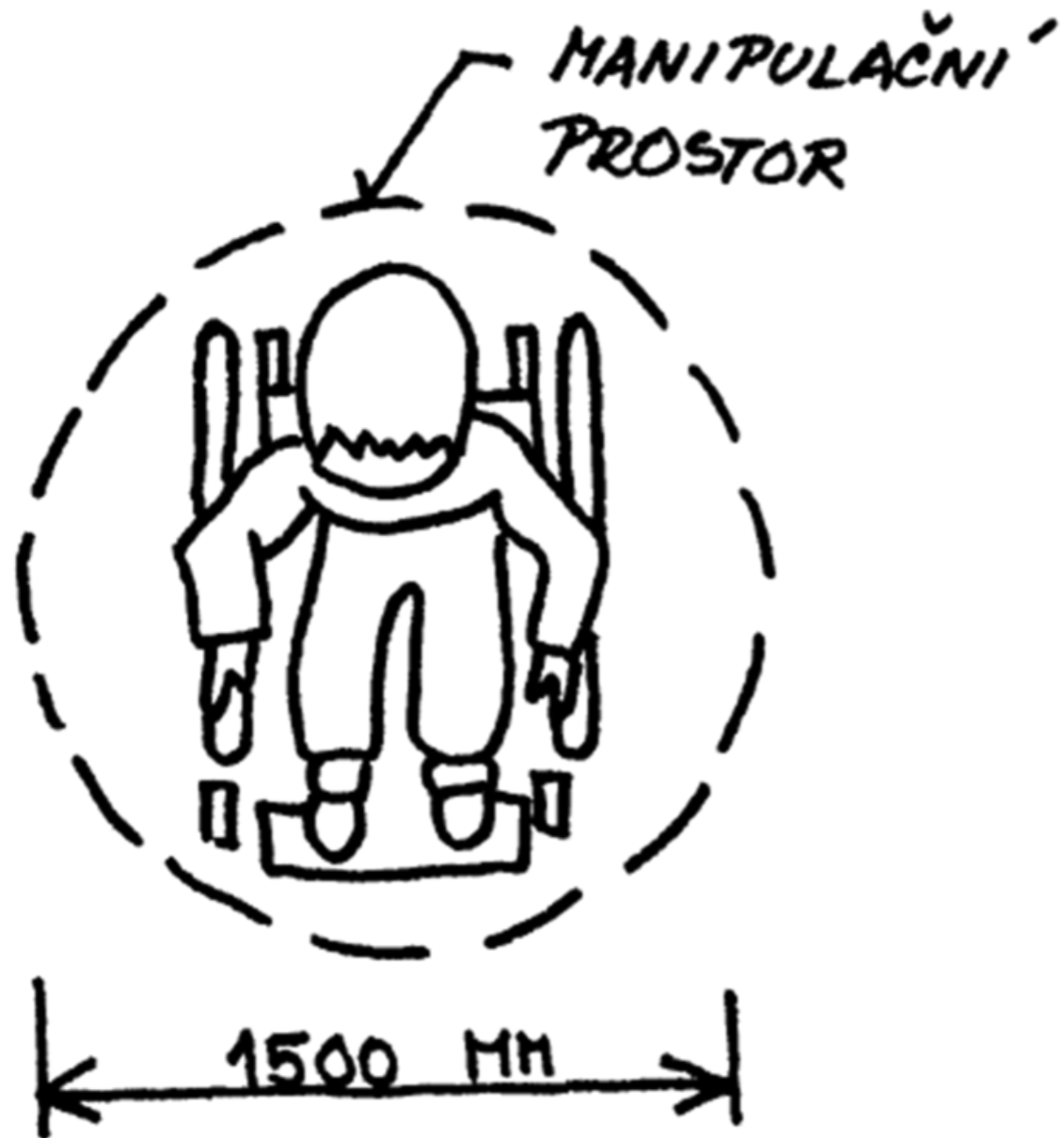

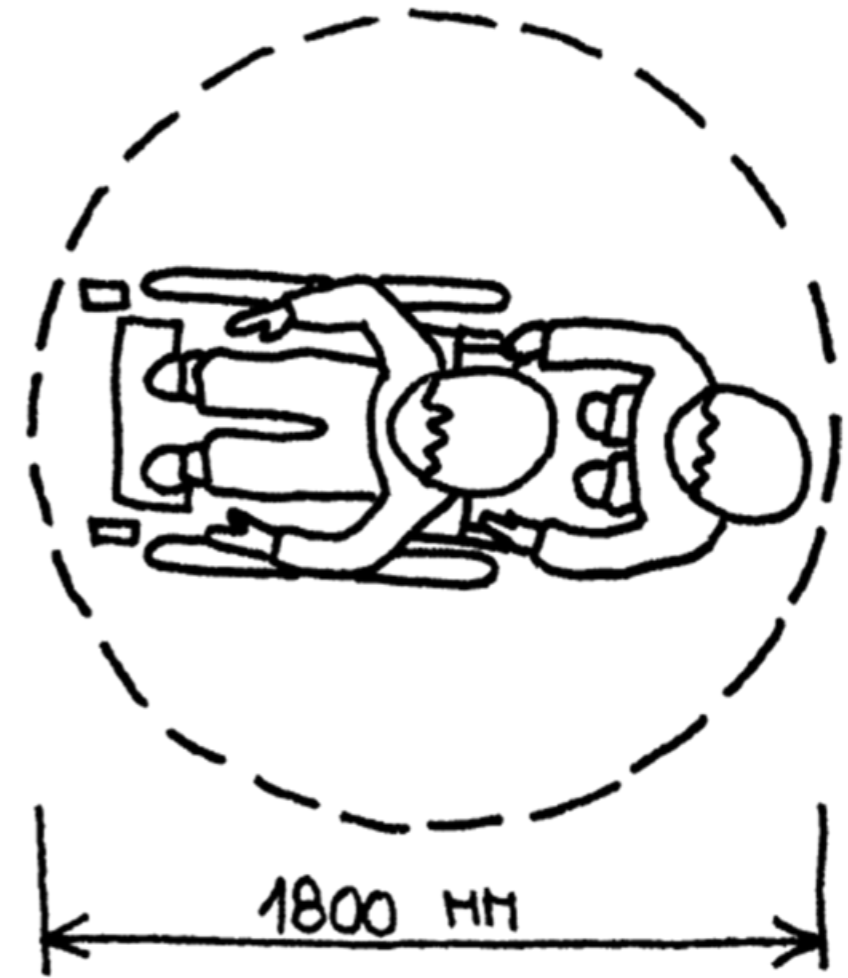
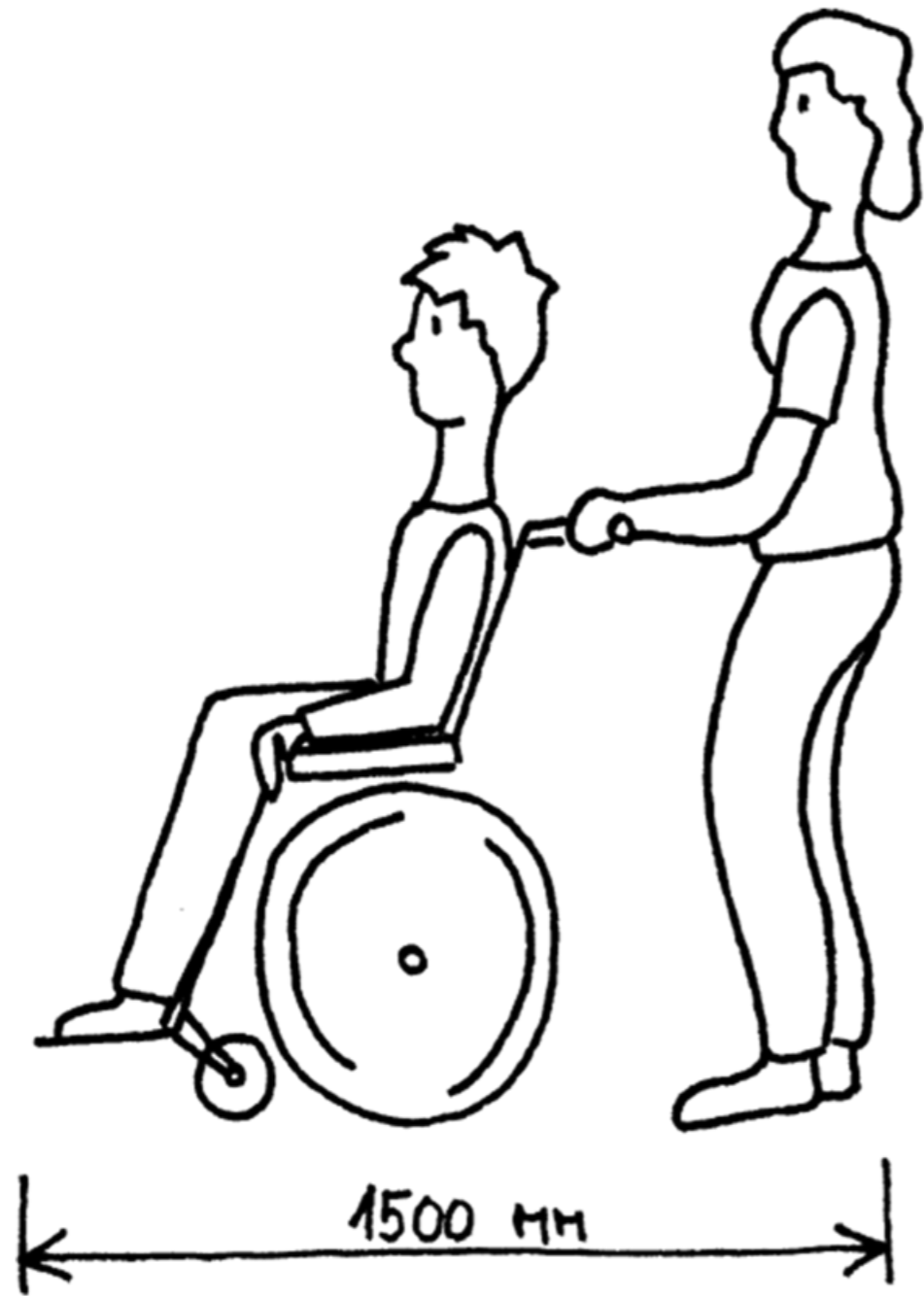

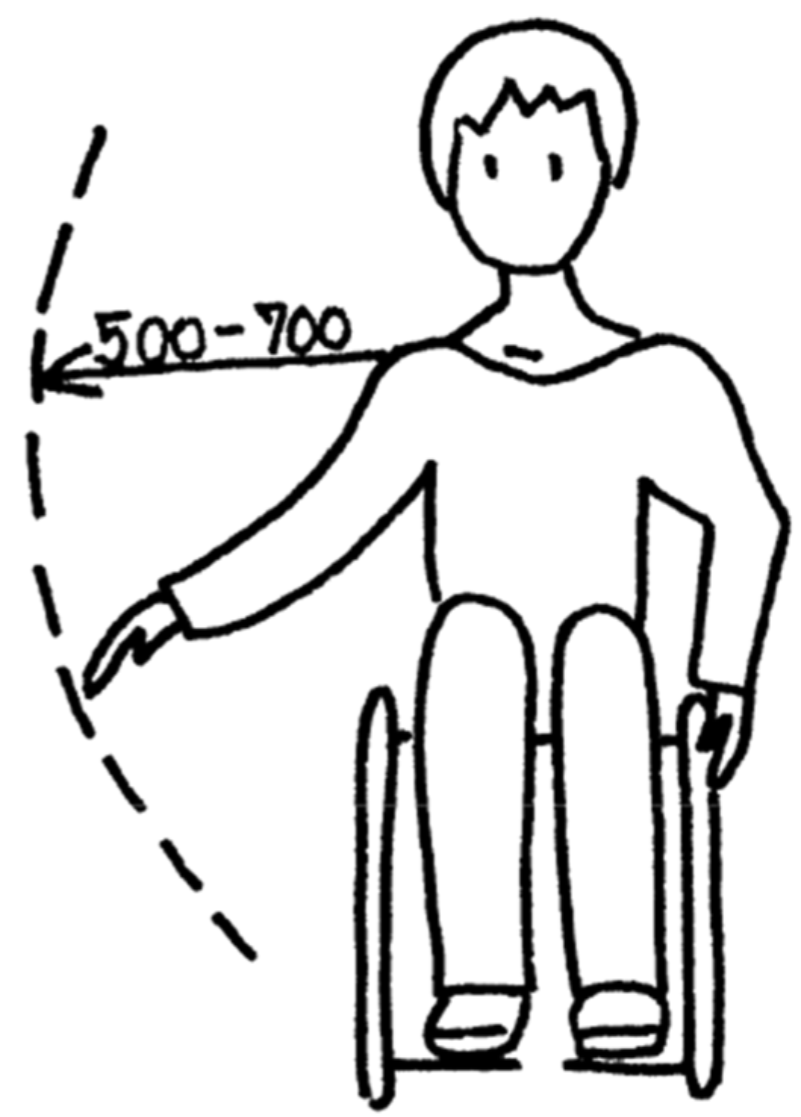
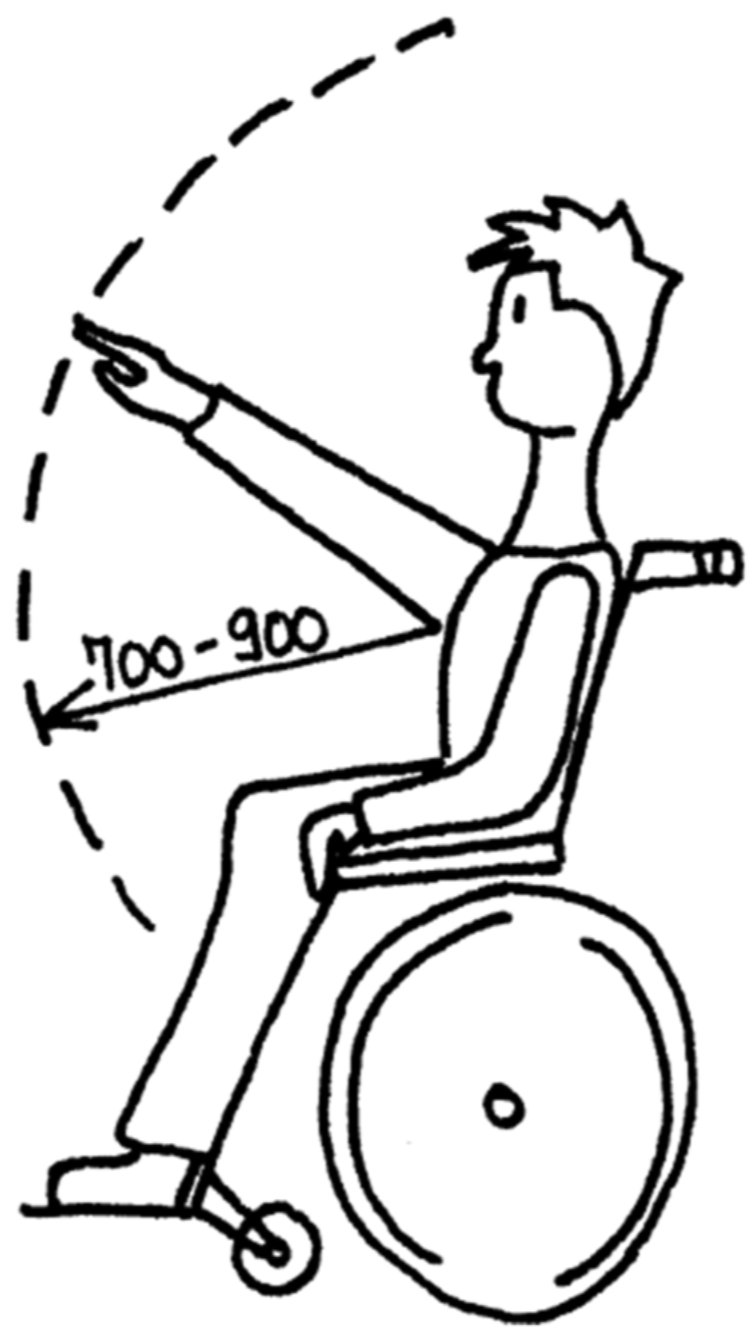

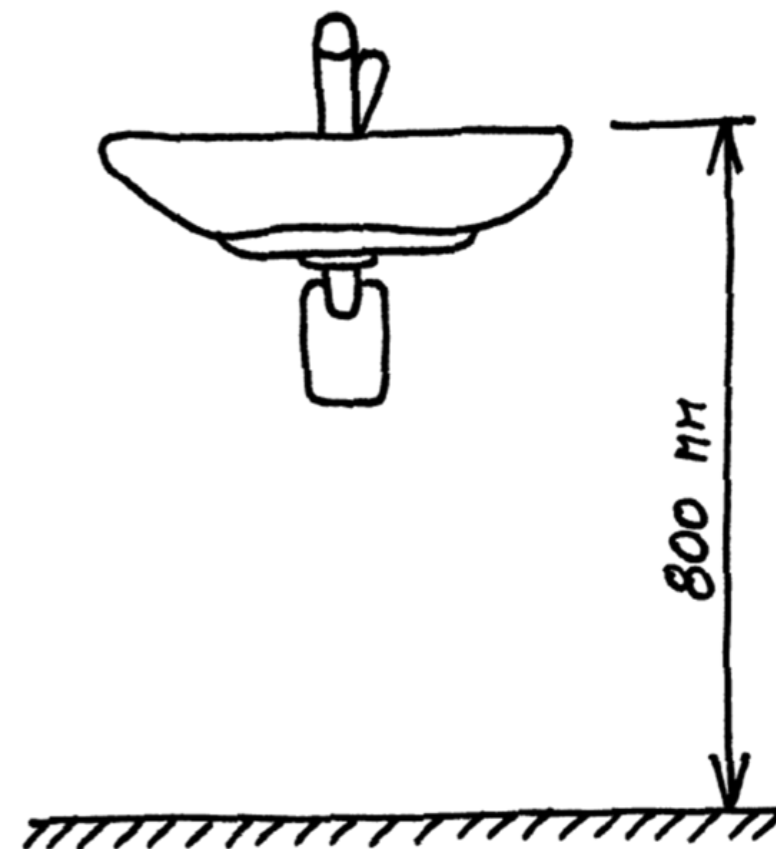
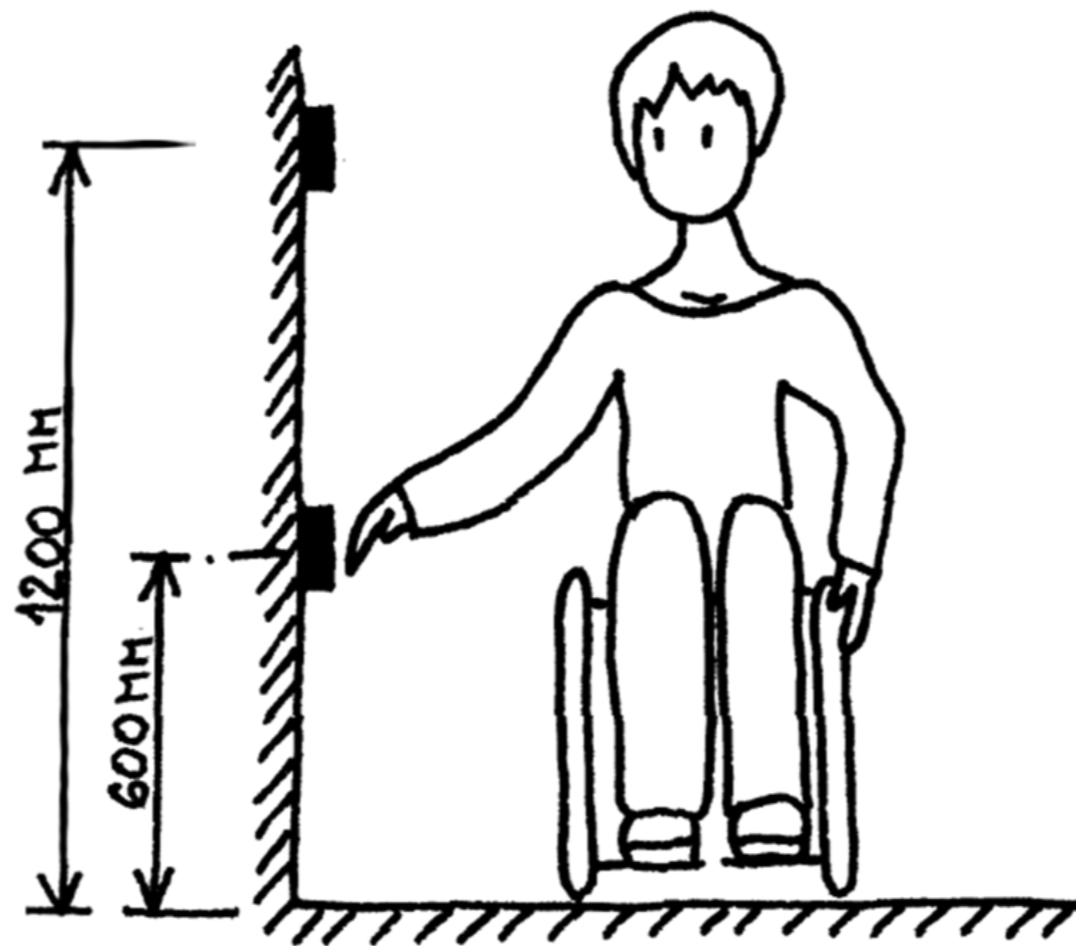
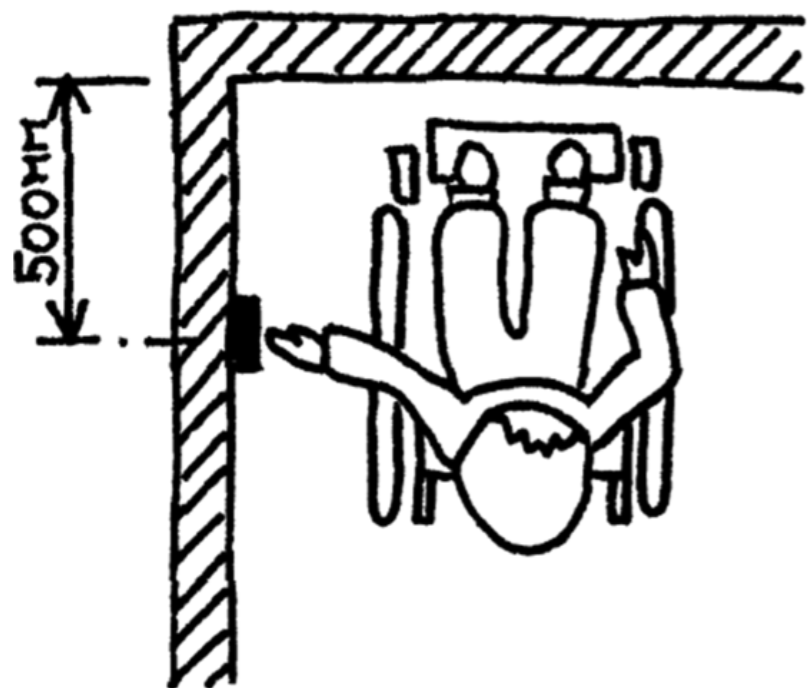





















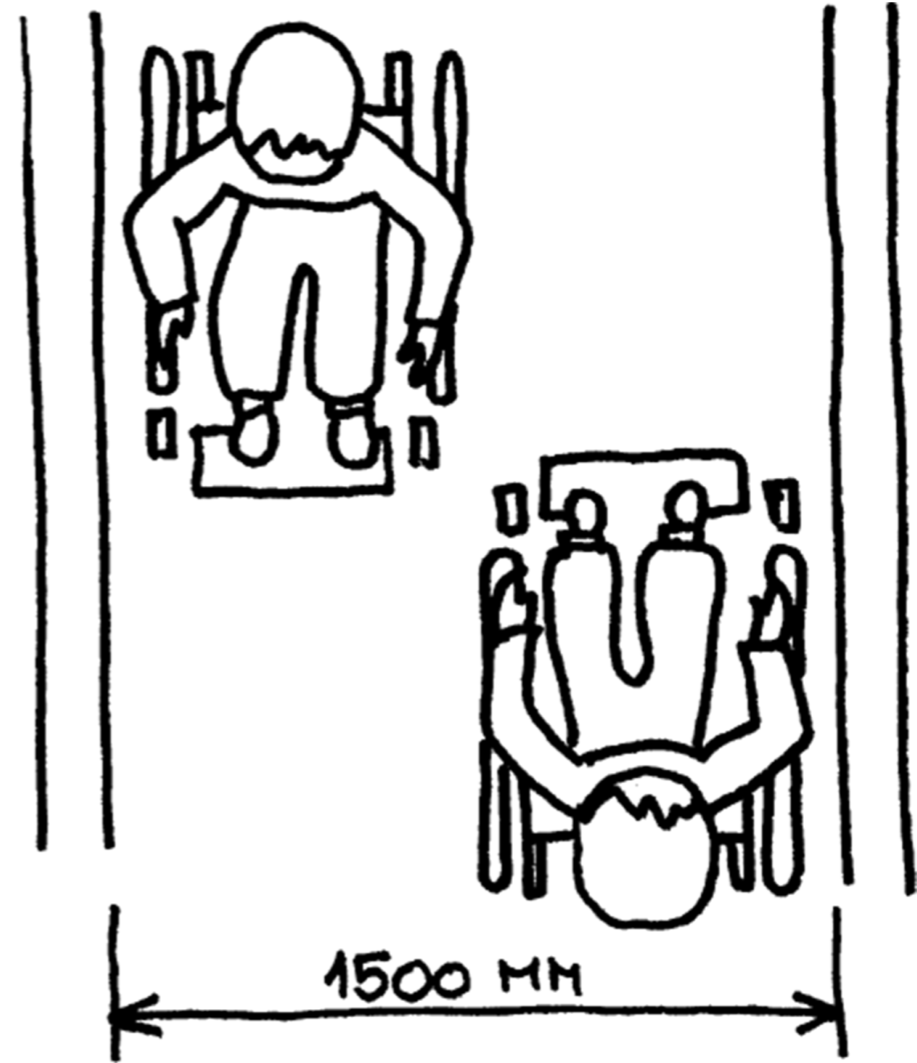
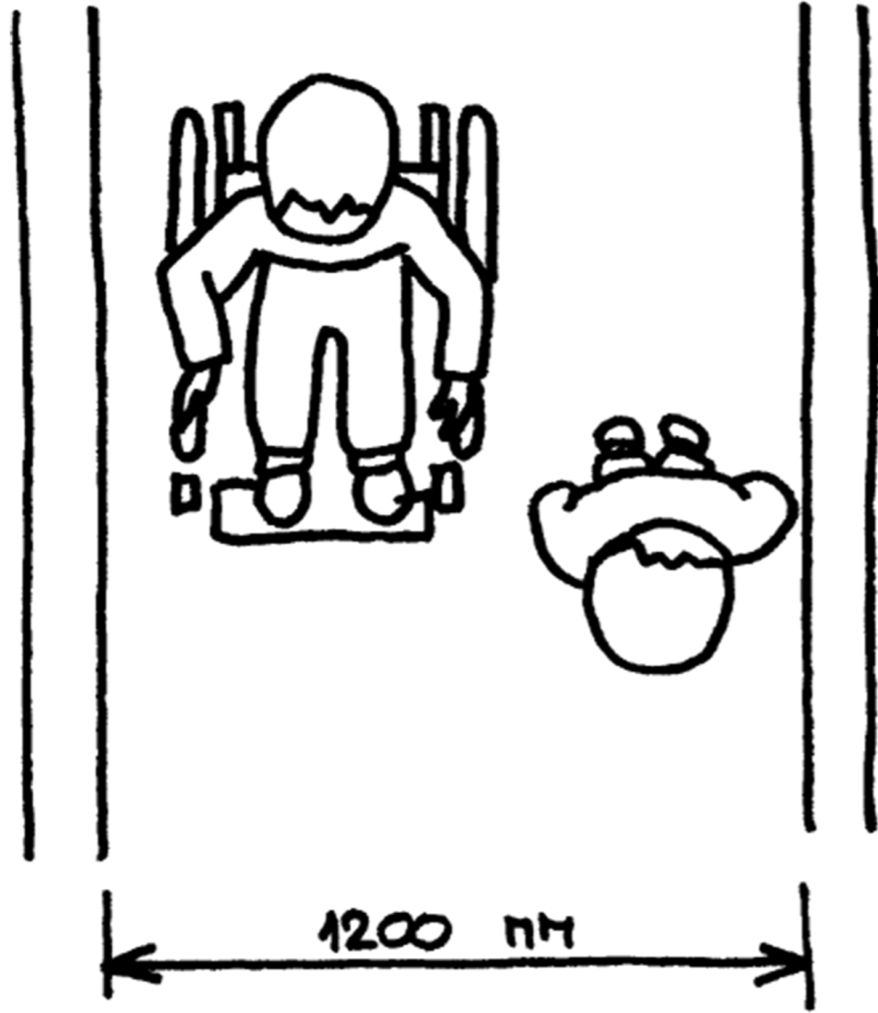

PĚŠKY, NA VOZÍKU, NA KOLE

HROMADNÁ DOPRAVA

AUTOMOBILOVÁ DOPRAVA



2

11 - 36



KO

SK - ZSK Bdghmeer 61 56 28-70

WC





DB BAHN





















76 TUALATIN

7676

Scotties
AUTO BODY
648-4275

1904

1904

186127





Tiyatro - Seminer
nel - Sergi - Konser

20 Kültür M
Ücretsiz Etkinli

YENİBOSNA

34
KESİKLİ
JEMALIN UYU

SHAHRAZAD
Internetová kavárna & čajovna

lanterie

LETNÍ
SHAKESPEAROVSKÉ
SLAVNOSTI BRNO 2017
19.7. - 8.8.
2017
PŮLKA SHAKESPEAROVA

SENIOR BUS
18718
TBR 6323





Dobrodružství
pod pantografem
Barbora Škoverová
na Klášterce
odeji

731 518 348



731 518 348

ZAPPER CENTRUM
prodej výrobků
firmy
Zapper
Technology
s.r.o.
měření
parazitální
zářiče
v lidském těle
www.zappercentrum.com

CELEK VOZIDEL POUŽÍVÁ
TŘEBÍČ

AUTOLIFT

PĚŠKY, NA VOZÍKU, NA KOLE

HROMADNÁ DOPRAVA

AUTOMOBILOVÁ DOPRAVA



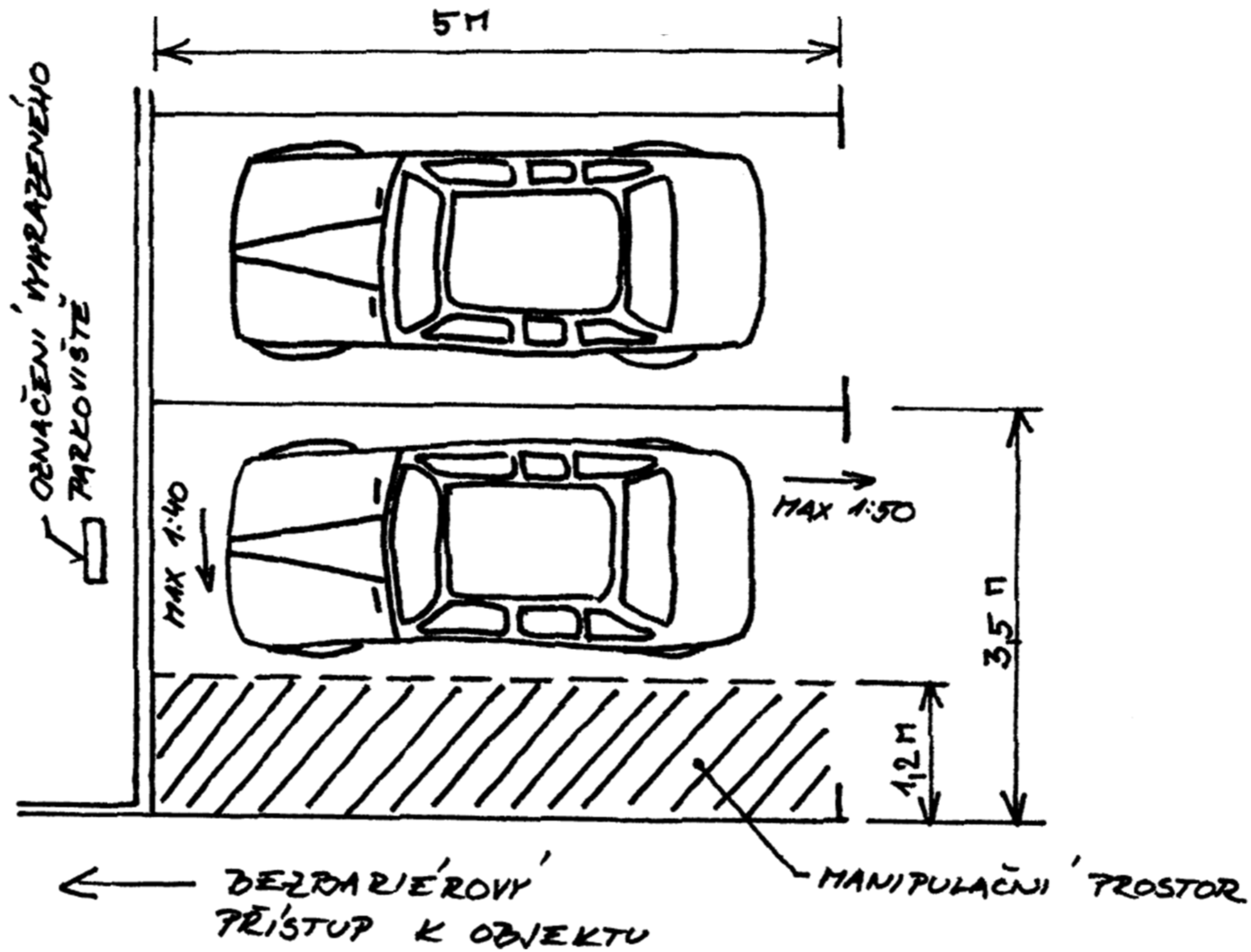

OBNAČENÍ VYHRANĚNÉHO
PARKOVIŠTĚ

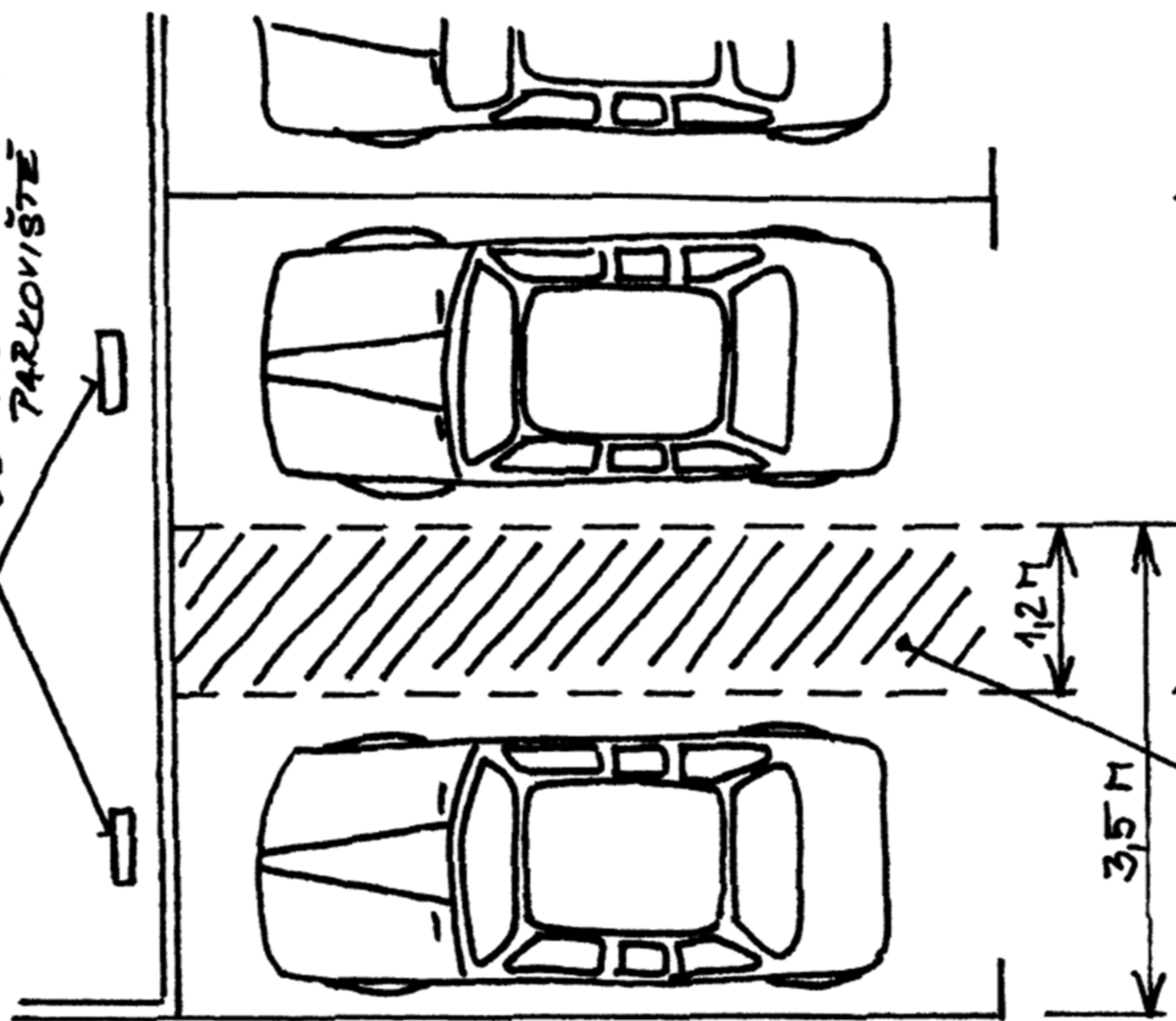

SPOLEČNÝ
MANIPULAČNÍ
PROSTOR

← BEZBARIÉROVÝ
PŘÍSTUP K OBJEKTU











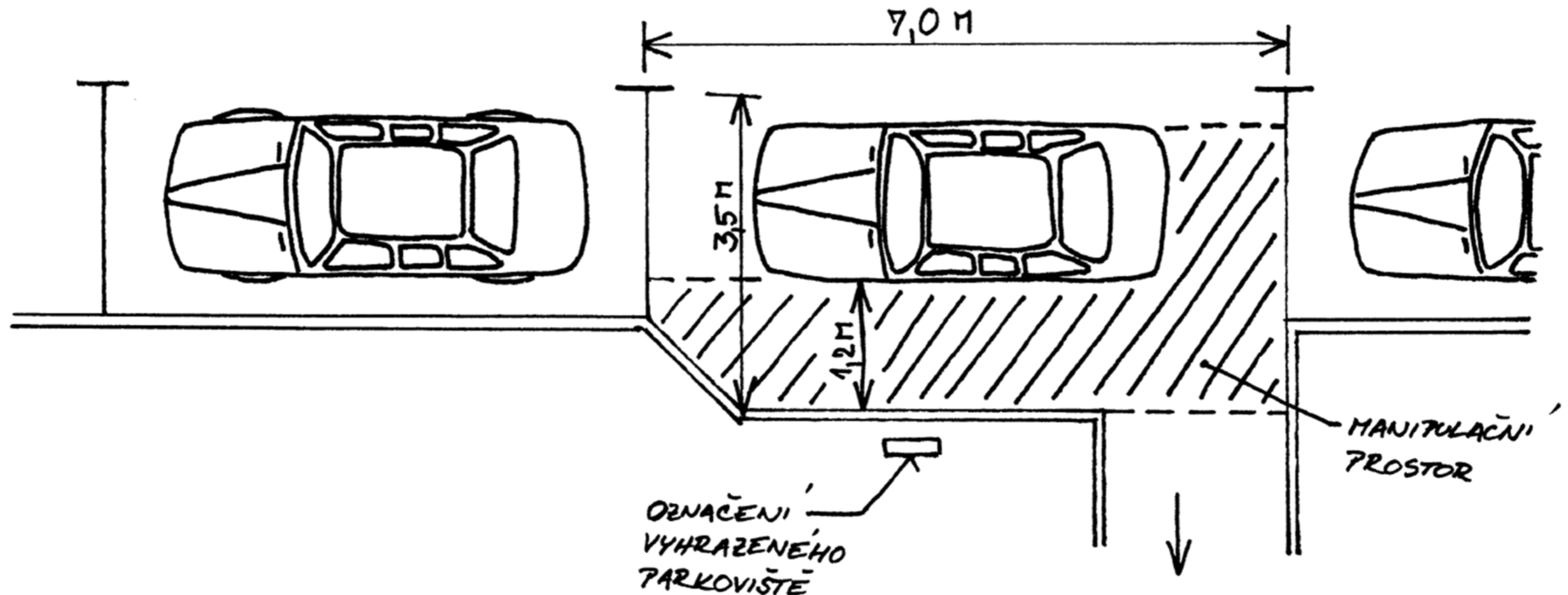

7,0 m

3,5 m

1,2 m

MANIPULAČNÍ PROSTOR

OZNAČENÍ VYHRAZENÉHO PARKOVISTĚ

BEZBARIÉROVÝ PŘÍSTUP K OBJEKTU











0 1
Označení vozidla
převážujícího
osobu těžce
postíženou na
zdraví



0 2
Označení vozidla
převážujícího
osobu těžce
pohybově
postíženou



0 3
Označení vozidla
řazeného osobou
sluchově
postíženou



0 4
Označení vozidla
řazeného řidičem
začátečnickem



0 5
Označení
autobusu
převážujícího
dětí



KURZPARKZONE
Parkdauer 3 Std.
von 6⁰⁰ bis 2⁰⁰

Reserviert für Frauen



KURZPARKZONE
Montag bis Sonntag
6h bis 21h
gebührenfrei
Parkdauer 3 Std.
Reserviert für Frauen













MANTIS



WE CAN ALWAYS
MANTIS
FIX YOUR BIKE

PLÁNOVÁNÍ MĚSTA

VEŘEJNÉ PROSTORY

MOBILITA



ATRAKTIVNÍ

BEZPEČNÉ

PŘÍSTUPNÉ















1SA 1109

735

734 14

734















Jan Merta
Návrat
21/2 - 5/5/2018



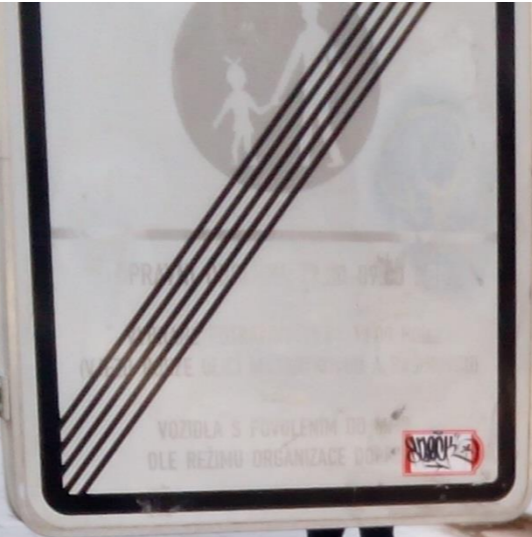

ORI

PĚŠÍ ZÓNA

PĚŠÍ ZÓNA
DOPRAVNÍ OBSLUHA
A CYKLISTÉ
00-24 hod.







ATRAKTIVNÍ

BEZPEČNÉ

PŘÍSTUPNÉ











Via S. Benedetto







ČESKÁ PODNIKATELSKÁ POJIŠŤOVNA

SWISS+COFFEE



nové pokoje

nícova

ATRAKTIVNÍ

BEZPEČNÉ

PŘÍSTUPNÉ

















749. Wien, IX. Himmelstreppe.

A. D. ...



Kein Parken
wegen Ladestellen
mit Aufstiegsanlagen
Anlieger

CD-ROM / BÜCHERTREFF

BÜCHERTREFF
im
Lichtentor

Zum Schutz Ihrer Gesundheit
TRINKWASSERFILTER

Ulrich







36

POLEVKARNA

POLEVKARNA
POD SCHODY
GALERIE

KARMAŘSKÉ PRODUKTY
POLKY
SALTY
JAKYKY



MIMO
OPRAVY
OVLIVNY

POLEVKARNA
POD SCHODY
POLKY + SLANÉ A SLADKÉ
Mládež 7. Brno tel. 78 337 018



Brixton

DOBŘE. LEPŠÍ. OD KREČITÁ

ASOVÁ































STAZIONE MARITTIMA

AUTORITÀ PORTUALE DI GENOVA











PSICHIATRI
UN VIAGGIO SENZA RIT















PŘÍSTUP K VODĚ





GONDOLAS**4ALL**



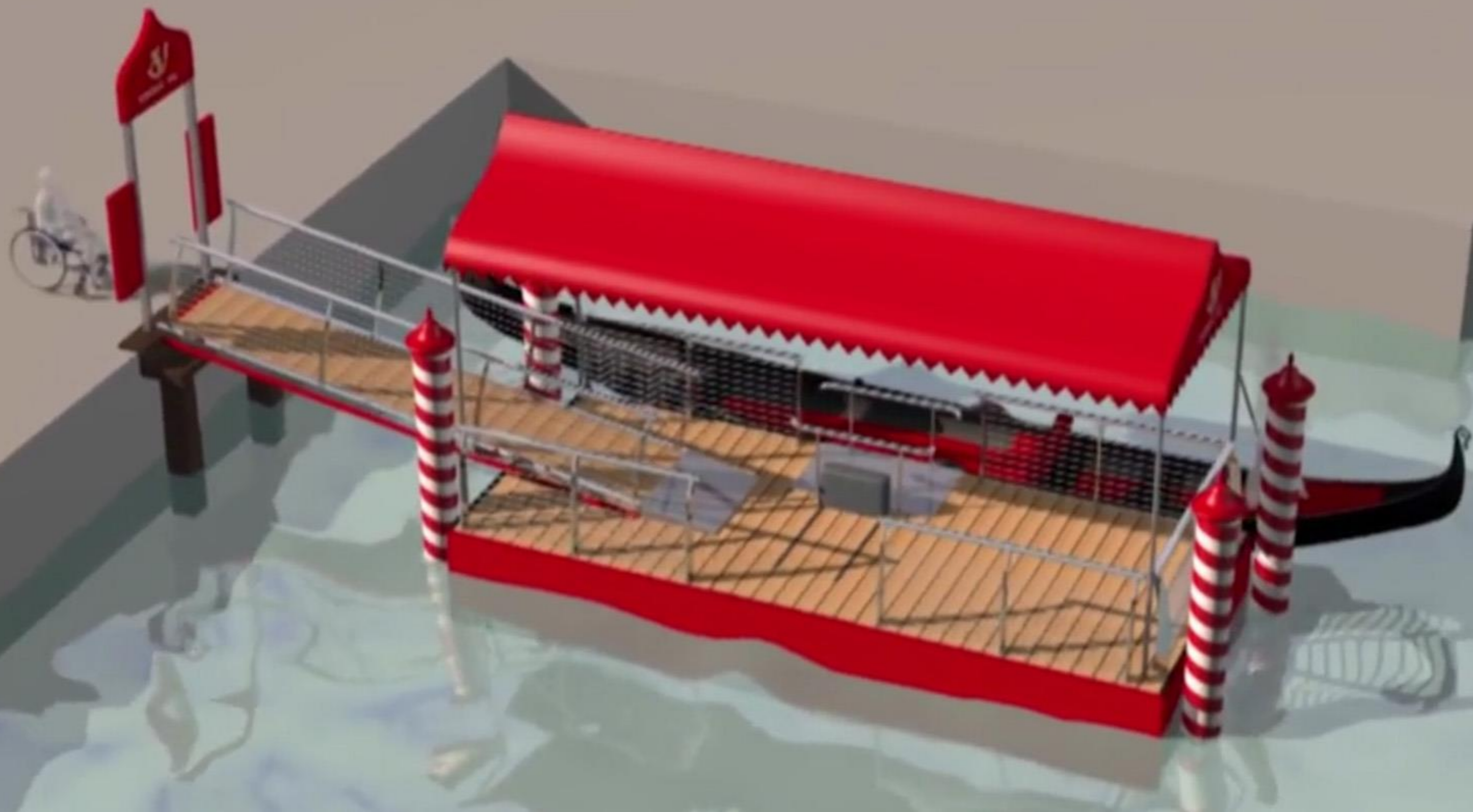

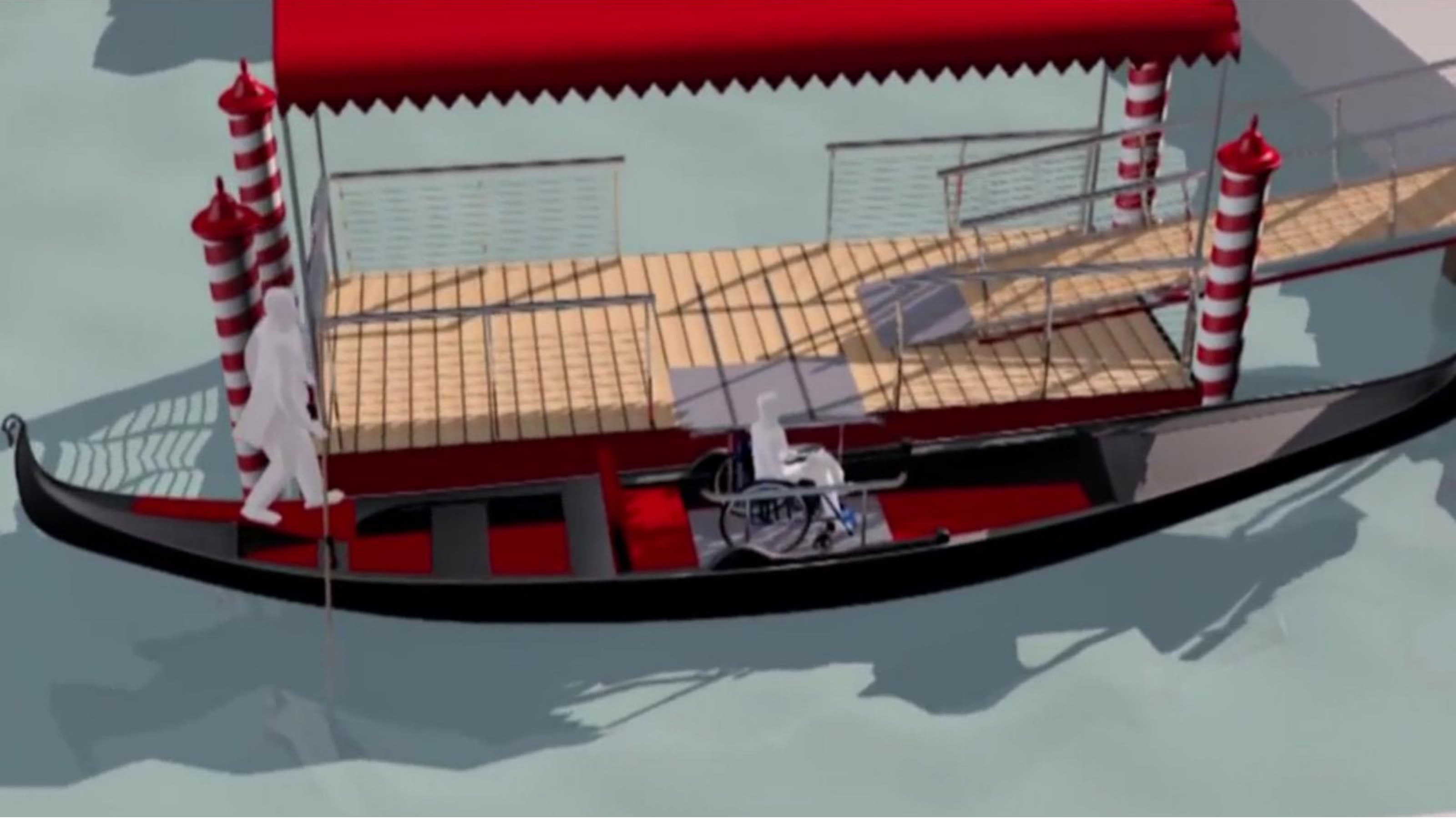



www.dpmh.cz

LIPSKO





P

PRÁVUJEME PRO VÁS
NOVÉ VEŘEŘOVÉ
PRISTAVIŠTĚ HRAD VEVEŘÍ

HRAD VEVEŘÍ

07-PR-8

















RESTAURANT

BAR

ADRENALIJUM

RESTAURANT









SERIOUS
ZADAR

pitter
www.pitter-yachting.com



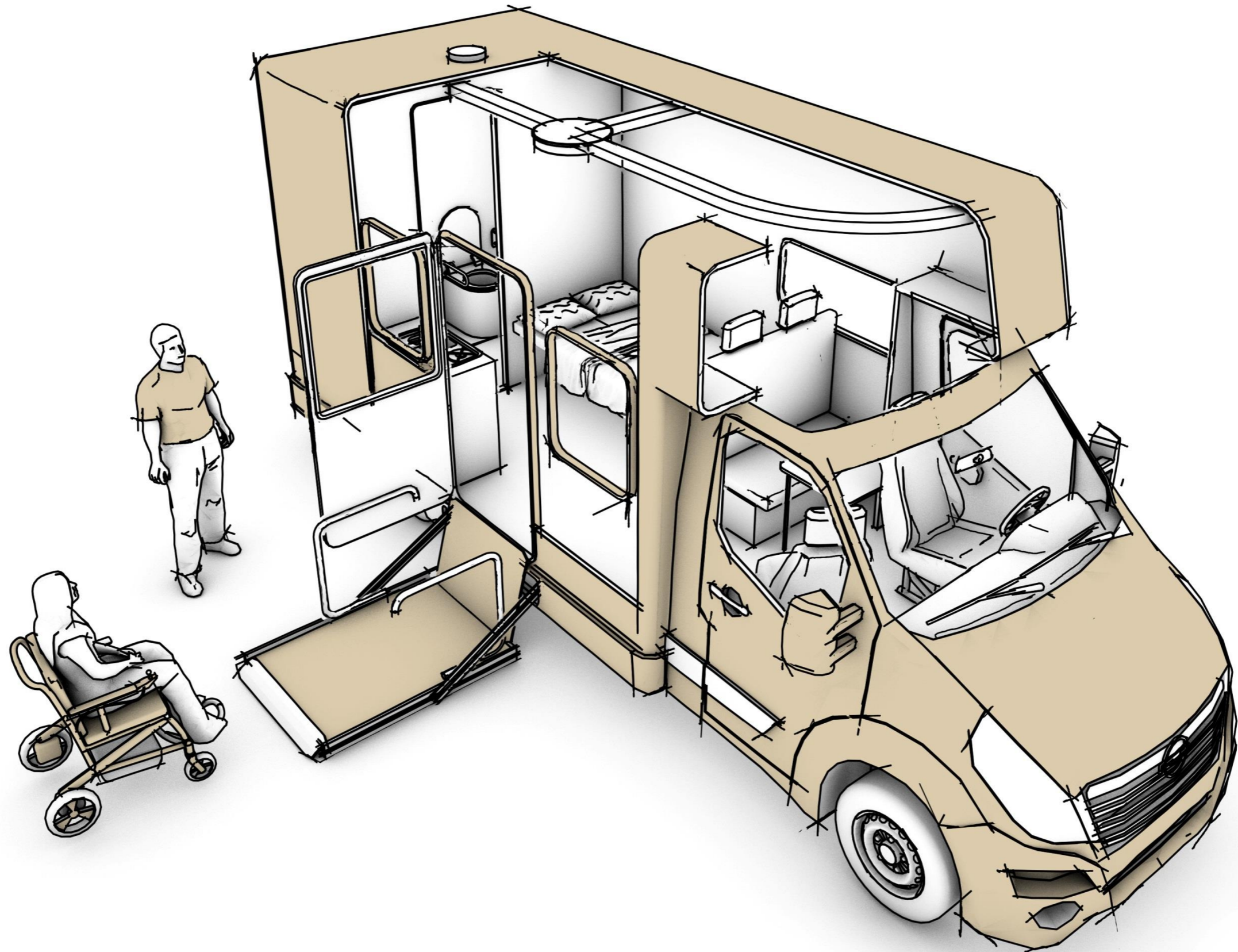



LIGA VOZÍČKÁŘŮ

Protože každý má svůj potenciál

www.ligavozic.cz

adam.erben@ligavozic.cz



**MINISTERSTVO
PRO MÍSTNÍ
ROZVOJ ČR**

Akce je realizována za přispění prostředků státního rozpočtu ČR z programu Ministerstva pro místní rozvoj.

